

# MODEL #XL2030

## UXL 20" x 30" Table

### DESIGN:

The UXL Table is built for today's education environment. The UXL line offers high schools and colleges a complete, integrated system for outfitting the entire school, from classrooms to commons.

### MATERIALS:

The 3/4" thick work surface consists of a 45 lb density particle board core with a 0.030" high pressure laminated surface and a 0.020" melamine backer sheet. The edge of the work surface features 3/4" bumper edge molding that is mechanically fastened to the underside of the work surface every 6 to 8 inches to assure a long lasting fit.

The frame is attached to the pre-drilled holes in the top. The legs then fasten into the frame at each corner. The table frame comes fully assembled requiring only two bolts per leg to complete installation. The table frame is a boxed tube design made of aircraft grade aluminum to reduce weight, while being very stable and sturdy. The 16-gauge steel legs are 2" diameter and powder coated for a long lasting durable finish. Legs are available in different configurations, see chart.

#### Optional Leg Choices (FL is standard)

Leg ABV.	Description	Height"	Casters	Glides
FL	Straight Fixed-Height Leg	29.5		✓
FC	Straight-Fixed Height Leg	29.5	✓	
AL	Push-Button Adjustable Leg	27-33		✓
AC	Push-Button Adjustable Leg	27-33	✓	
SL	Push-Button Adjustable Leg	24-29		✓
SC	Push-Button Adjustable Leg	24-29	✓	
TG	Tapered Fixed-Height Leg	29.5		✓
TL	Tapered Fixed-Height Leg	29.5	✓	

### DIMENSIONS & FREIGHT:

Model	Description	D"	W"	H"	F.C.	Cube	Wt.	UPS
UXL 20" x 30" Rectangle								
XL2030	UXL 20"x30" Single-Student	20	30	24-33	70	1.4	50	✓
	XL2030 Carton #1 Dimensions	15.625	30	3				
	XL2030 Carton #2 Dimensions	25.125	36.5	3				

### PRODUCT SPECIFICATIONS:

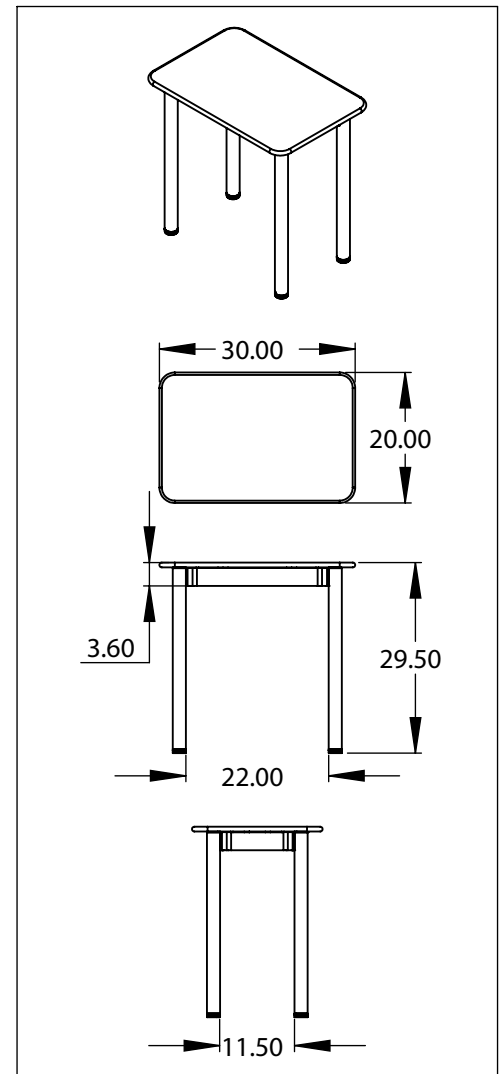

### AVAILABLE COLORS:

#### Standard Laminate Desk Top Color Choice



#### Frame Color Choice



#### Edge Molding Color Choice



WWW.SMITHSYSTEM.COM

