

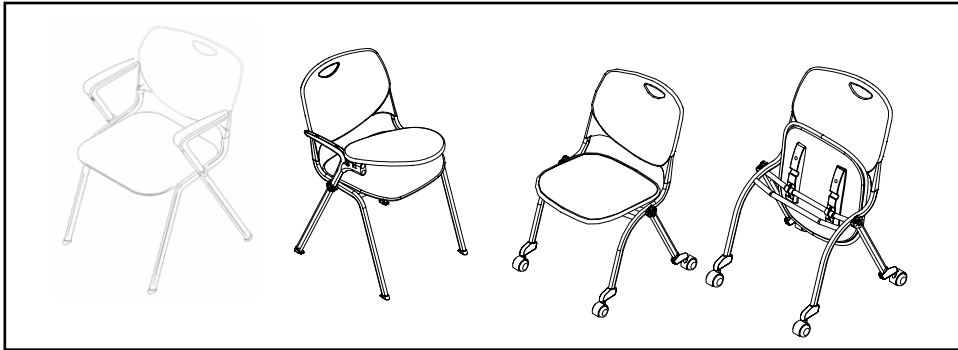

## UXL Chair/Nest & Fold Chair; Arm Installation

### Assembly Instructions



#### UXL Chair / Nest & Fold Chairs with Arms Part Numbers:

UXL 18" Stack Chair with Arm(s):

XL183P\_P\_LR = UXL 18" Stack Chair with Left & Right Arms

UXL 18" Nest & Fold Chair with Arm(s):

NF187F\_P\_LR = UXL 18" Nest & Fold Chair with Left & Right Arms.

UXL 18" Chair with FoldAway Tablet Arm:

XL183P\_P\_NF = UXL 18" Chair with Right FoldAway Tablet Arm,.

XL183P\_P\_FN = UXL 18" Chair with Left FoldAway Tablet Arm.

**For assistance in assembling product, missing or damaged parts, or to place an order please contact customer service at 1-800-328-1061. You may also place your order online at**

**[www.smithsystem.com](http://www.smithsystem.com)**

## Special Notes:

1. Check that all components are accounted for and undamaged before assembling.
2. Please assemble product in a clean and dry area.
3. For larger units you may need another person to help assemble the product.
4. Clean the product with a mild cleaner and a damp cloth.

### Tools:

1. M4 Allen Key (Supplied) 	2. Flathead Screwdriver (*Not Supplied*)	3. Rubber Mallet (*Not Supplied*)
---	---	--------------------------------------

### Components:

1. Arm Option;



a. Stack Chair Arm



b. Foldaway Tablet Arm



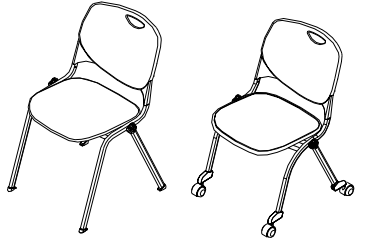

2. Assembled 18" UXL Stack Chair **or** UXL Nest & Fold Chair.



### Notes:

If you have damaged or missing components or hardware please contact customer service at 1-800-328-1061

## UXL 18" Stack Chair/Nest & Fold Arm Attachment Directions

<p><b>Step 1:</b> Using the 4mm Allen Key, loosen the side screw completely. Pop out the plastic cap/cover with a flathead screwdriver on the side where the Arm will be placed.</p>	 <p>(1)</p>
<p><b>Step 2:</b> With the cap removed and the screw loosened completely, slide the Arm into the empty socket and press firmly down to seat the Arm. (In some cases a rubber mallet may be needed to seat the Arm flush in the socket).</p>	 <p>(2)</p>
<p><b>Step 3:</b> With the Arm seated flush in the socket, use the 4mm Allen Key to tighten the side screw completely. If attaching both Left &amp; Right Arms, repeat steps 1-3 for opposite Arm. Your UXL Chair is now ready for use.</p>	 <p>(3)</p>
<p><b>Step 4:</b> Final tightening of the side screw.</p>	 <p>(4)</p>