

acrobat student desk

model #: 26393

24" x 36" acrobat single-student desk

DIMENSIONS + FREIGHT:

MODEL #	D"	W"	H"	F.C.	CUBE	WEIGHT
26393	24"	36"	24" - 36"	70	3.4	88 lbs.
carton	25.13"	39.3"	3"			

OVERVIEW:

The strong, stable Acrobat Student Desks can be used separately or in multiple combinations. It features a built-in wire raceway in the modesty panel for cable management.

The 1 1/4" thick **WORK SURFACE** consists of a 45 lb. density particle board core with a .030" high-pressure laminated surface and a .020" melamine backer sheet. The edge of the work surface features 3/8" bumper edge molding that is mechanically fastened every 6 to 8 inches to assure a long lasting fit. The top is pre-drilled for ease of installation.

The **LEGS** are telescoping which allows height adjustment from 24" to 36" high. The legs are 1 5/8"W x 10"D double wall panel constructed of 12, 14 and 18-gauge steel with rounded edges. Cable ports in the upper leg create networking options from station to station and in the lower leg cable ports provide routing to the floor. The **BASE** is 16-gauge steel tube 1 3/4" x 2" nylon caps protect the feet. The legs also have 1" adjusting leveling glides.

The **MODESTY PANEL** is made from 18-gauge steel and features a built in raceway and cable ports in the upper corners. The panel connects to the worksurface and legs. Acrobat workstations can go mobile with optional dual-wheel casters:

- Model #17576 = 3" diameter
- Model #17554 = 4" diameter

ACROBAT TOP & EDGE PROFILE

1 1/4" TOP

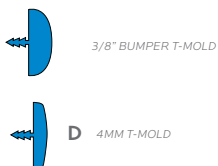

ADD POWER



MODEL	DESCRIPTION
017091 SLV	2 power

Model 26393. Shown in Maple with Mint edge and Platinum frame. Shown with optional Intuit Adjustable Chair in Mint, Model 00531.

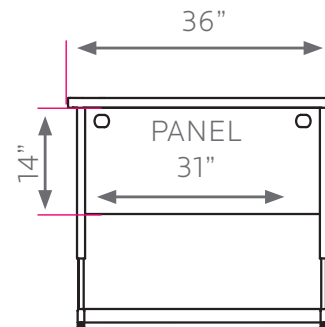
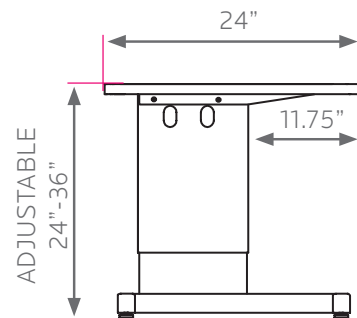

make it mobile with casters 3" or 4" dual-wheel

Frame Color Options



BLACK



PLATINUM

Standard Laminate Options

Want to specify a different laminate?

No problem. If you have 20 or more tops of the same color -60 or -38 there is no upcharge. Have 20 or less? We can quote for you with the Wilsonart code and – finish style. We can specify other laminates – call to inquire and get a quote.



Suggested Standard Laminates:



ASIAN NIGHT
7949-60



BOARDWALK OAK
7983-60



PEWTER MESH
4878-60



CLASSIC LINEN
4943-60



HIGH RISE
4996-60



BUKA BARK
7982-60



PALISADES OAK
7987-60



FLAX LINEN
4990-60



MISSION MAPLE
7990-60



NEW AGE OAK
7938-60

Classic Standard Laminates:



WILD CHERRY
7054-60

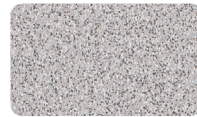

GREY NEBULA
4622-60



FUSION MAPLE
7909-60

All 13 of the standard laminates are -60 finish, if you need to match a laminate from a previous year, please let us know on your order (example Pewter Mesh 4878-38, our standard is -60).

When the WilsonArt Laminate code includes a "Y", "K", "-12" "-78", "Aeon" etc, these are special laminates with an upcharge, even when it contains -38 or -60.

Standard Edge Color Options



APPLE



BLACK



BLUEBERRY



BURGUNDY



CERULEAN



CHAMPAGNE



CHARCOAL



CHOCOLATE



CLEMENTINE



FOREST GREEN



FUCHSIA



MINT



MOCHA



NAVY



ORANGE



PERSIAN BLUE



PLATINUM



PURPLE



RED



YELLOW