

acrobat student desk

model #: 26413

24" x 60" acrobat two-student desk

DIMENSIONS + FREIGHT:

MODEL #	D"	W"	H"	F.C.	CUBE	WEIGHT
26413	24"	60"	24" - 36"	70	5.1	113 lbs.
carton	25.13"	63.3"	3"			

OVERVIEW:

The strong, stable Acrobat Student Desks can be used separately or in multiple combinations. It features a built-in wire raceway in the modesty panel for cable management.

The 1 1/4" thick **WORK SURFACE** consists of a 45 lb. density particle board core with a .030" high-pressure laminated surface and a .020" melamine backer sheet. The edge of the work surface features 3/8" bumper edge molding that is mechanically fastened every 6 to 8 inches to assure a long lasting fit. The top is pre-drilled for ease of installation.

The **LEGS** are telescoping which allows height adjustment from 24" to 36" high. The legs are 1 5/8"W x 10"D double wall panel constructed of 12, 14 and 18-gauge steel with rounded edges. Cable ports in the upper leg create networking options from station to station and in the lower leg cable ports provide routing to the floor. The **BASE** is 16-gauge steel tube 1 3/4" x 2" nylon caps protect the feet. The legs also have 1" adjusting leveling glides.

The **MODESTY PANEL** is made from 18-gauge steel and features a built in raceway and cable ports in the upper corners. The panel connects to the worksurface and legs. Acrobat workstations can go mobile with optional dual-wheel casters:

- Model #17576 = 3" diameter
- Model #17554 = 4" diameter

ACROBAT TOP & EDGE PROFILE

1 1/4" TOP

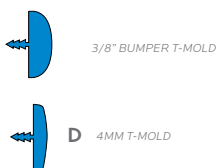

Model 26283. Shown in Grey Mesh with White edge and Platinum frame. Shown with optional Flavors Stack Chair in Apple, Model 11849.

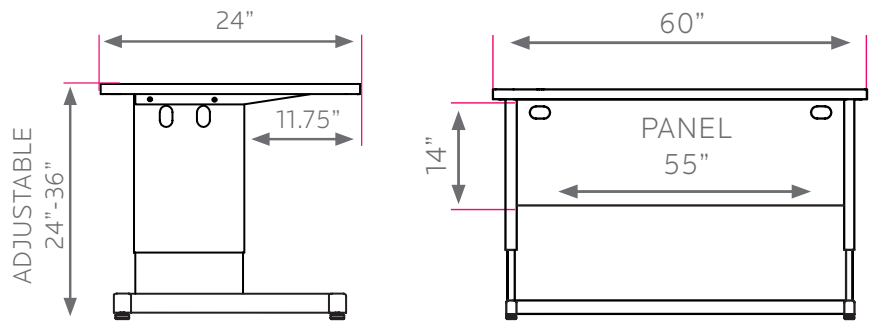

FRAME

- BLACK
- PLATINUM

make it mobile with casters 3" or 4" dual-wheel

EDGE CHOICES

- APPLE
- BLACK
- BLUEBERRY
- BURGUNDY
- CERULEAN
- ORANGE
- CHAMPAGNE
- CHARCOAL
- CHOCOLATE
- CLEMENTINE
- FOREST GREEN
- FUCHSIA
- MINT
- MOCHA
- NAVY
- PERSIAN BLUE
- PURPLE
- RED
- WHITE
- YELLOW
- PLATINUM

LAMINATE CHOICES

- AMBER CHERRY
- ASIAN NIGHT
- BLOND ECHO
- FUSION MAPLE
- GOLDEN OAK
- GREY MESH
- GREY NEBULA
- NEW AGE OAK
- PEWTER MESH
- TAN ECHO
- WILD CHERRY

ADD POWER



MODEL	DESCRIPTION
017091 SLV	2 power