

planner student desk 24" x 72"

model #: 01290

two-student 24" x 72"

DIMENSIONS + FREIGHT:

MODEL #	D"	W"	H"	F.C.	CUBE	WEIGHT
01290	24"	72"	22" - 32"	70	3.1	83 lbs.
carton	30"	72"	7"			

OVERVIEW:

The Planner is a truly stronger student desk. Shipped ready to assemble, these desks have a heavy-duty work surface that won't sag under heavy books or equipment.

The 1 1/4" or 3/4" thick **WORK SURFACE** consists of a 45 lb density particle board core with a .030" high pressure laminated surface and a .020" melamine backer sheet. The edge of the work surface features t-mold edge molding that is fastened every 6 to 8 inches to assure a long lasting fit.

The **FRAME** is attached to the pre-drilled holes in the top with (12) #10 x 5/8" screws through a 3 1/8"W x 18"L 14-gauge steel mounting plate. The mounting plate is welded to (2) 1 1/4" square 14-gauge steel tube legs which is welded to a 1" square 14-gauge steel tube and adjust in height from 22" to 32" in 1" increments. The adjustment for each leg is secured with (2) 3 3/4" -16 x .675" Allen screws. The right and left leg both include the Smith System patented backpack peg allowing for either inside or outside positioning. The legs are tied together for added strength with a 6" high 18-gauge steel panel and (4) Connector Bolts. Legs have 1" adjusting leveling glides.

PLANNER DESK TOP & EDGE PROFILE

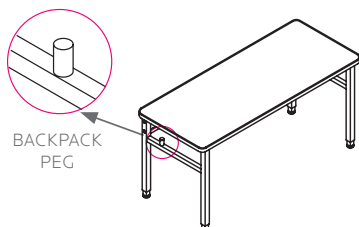
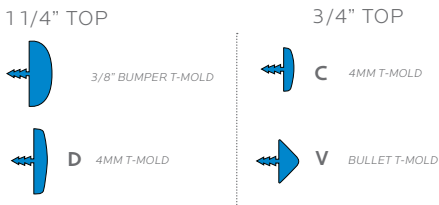

Model 01290 24" x 72" shown with optional steel bookboxes model #17190

Make it mobile with 3" casters
Order Model 17576

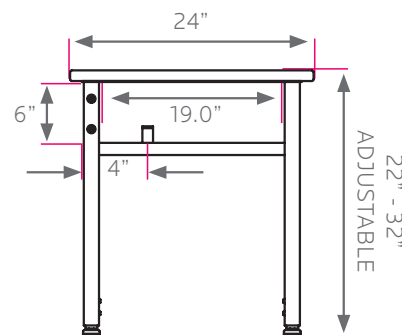
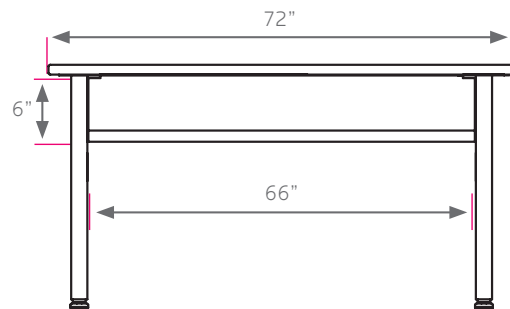

*see catalog for all optional parts & accessories.

Frame Color Options



BLACK
BLA



PLATINUM
PLT

Standard Laminate Options

Want to specify a different laminate?

No problem. If you have 20 or more tops of the same color -60 or -38 there is no upcharge. Have 20 or less? We can quote for you with the Wilsonart code and – finish style. We can specify other laminates – call to inquire and get a quote.



Suggested Standard Laminates:



ASIAN NIGHT
7949-60
ANG



BOARDWALK OAK
7983-60
BWK



PEWTER MESH
4878-60
PEW



CLASSIC LINEN
4943-60
CLN



HIGH RISE
4996-60
HRE



BUKA BARK
7982-60
BBK



PALISADES OAK
7987-60
PSO



FLAX LINEN
4990-60
FLL



MISSION MAPLE
7990-60
MIM



NEW AGE OAK
7938-60
NEW

Classic Standard Laminates:



WILD CHERRY
7054-60
CHE

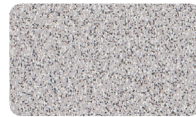

GREY NEBULA
4622-60
GNB



FUSION MAPLE
7909-60
MAP

All 13 of the standard laminates are -60 finish, if you need to match a laminate from a previous year, please let us know on your order (example Pewter Mesh 4878-38, our standard is -60).

When the WilsonArt Laminate code includes a "Y", "K", "-12" "-78", "Aeon" etc, these are special laminates with an upcharge, even when it contains -38 or -60.

Standard Edge Color Options



APPLE A



BLACK B



BLUEBERRY C



BURGUNDY D



CERULEAN S



CHAMPAGNE O



CHARCOAL R



CHOCOLATE Q



CLEMENTINE E



FOREST GREEN F



FUCHSIA G



MINT H



MOCHA T



NAVY I



ORANGE U



PERSIAN BLUE J



PLATINUM P



PURPLE K



RED L



YELLOW N