

# large round end multi-media table

model #: 04137

interchange round end multi-media

**DIMENSIONS + FREIGHT:**

MODEL #	D"	W"	H"	F.C.	CUBE	WEIGHT
04137	72.75"	60.5"	22" - 34"	70	10.0	170 lbs.

**OVERVIEW:**

Table lines flair to provide clear sightlines for multi-person viewing and participation in distance learning or other presentation application. Large 72" long table accomodates two people comfortably along sides and two people at the head. Ideal for conference rooms hosting multimedia applications.

The **WORK SURFACE** consists of a 45 lb density particle board core with a 0.030" high pressure laminated surface and a 0.020" backer sheet. The edge of the work surface features T-mold that is stapled to the underside of the work surface every 6"-8".  
**FRAME** consists of two fully welded segments. Ellipse shaped tubes measure 1.5" x 2.5". 16 gauge leg inserts and leg stems are welded to 14 gauge plates. The pre-drilled top is standard at 1 1/4" thick and available in 3/4" thick option. Laminate and T-mold color and style options are listed below. Top is predrilled to attach to legs using included fasteners. Legs include a 1" adjustable leveling glide with a locking stop to provide stability on uneven floors.

**INTERCHANGE TOP & EDGE PROFILE**

1 1/4" TOP

3/4" TOP

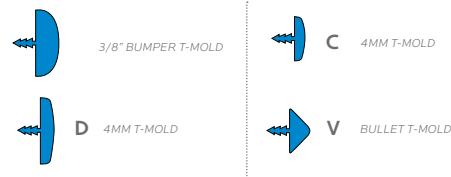

**optional interchange casterpacks:**

**Make it mobile with 3" casters**  
Order Model 17576  
Black or Platinum cap available.

**ADD POWER**



#017085 / #017092 #017093 / #017086

add TV mount #17354

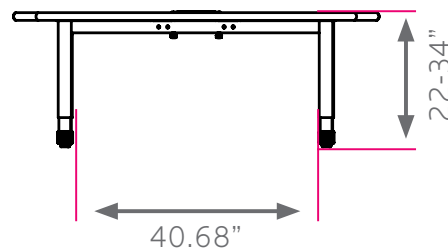
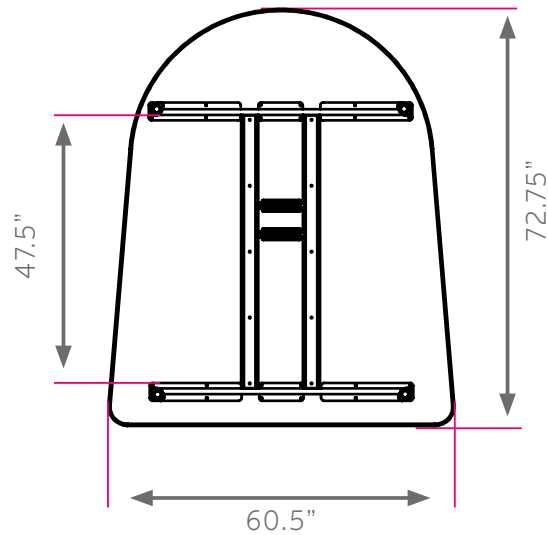

## Interchange™ Frame Color Options



BLACK  
BLA



PLATINUM  
PLT

## Standard Laminate Options

Want to specify a different laminate?

No problem. If you have 20 or more tops of the same color -60 or -38 there is no upcharge. Have 20 or less? We can quote for you with the Wilsonart code and – finish style. We can specify other laminates – call to inquire and get a quote.



Suggested Standard Laminates:



ASIAN NIGHT  
7949-60  
ANG

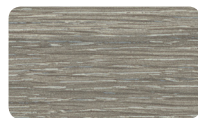

BOARDWALK OAK  
7983-60  
BWK

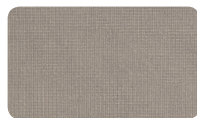

PEWTER MESH  
4878-60  
PEW



CLASSIC LINEN  
4943-60  
CLN



HIGH RISE  
4996-60  
HRE



BUKA BARK  
7982-60  
BBK



PALISADES OAK  
7987-60  
PSO

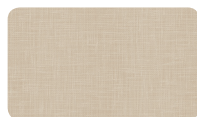

FLAX LINEN  
4990-60  
FLL



MISSION MAPLE  
7990-60  
MIM



NEW AGE OAK  
7938-60  
NEW

Classic Standard Laminates:



WILD CHERRY  
7054-60  
CHE

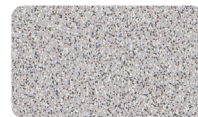

GREY NEBULA  
4622-60  
GNB



FUSION MAPLE  
7909-60  
MAP

All 13 of the standard laminates are -60 finish, if you need to match a laminate from a previous year, please let us know on your order (example Pewter Mesh 4878-38, our standard is -60).

When the WilsonArt Laminate code includes a "Y", "K", "-12" "-78", "Aeon" etc, these are special laminates with an upcharge, even when it contains -38 or -60.

## Standard Edge Color Options



APPLE A



BLACK B



BLUEBERRY C



BURGUNDY D



CERULEAN S



CHAMPAGNE O



CHARCOAL R



CHOCOLATE Q



CLEMENTINE E



FOREST GREEN F



FUCHSIA G



MINT H



MOCHA T



NAVY I



ORANGE U



PERSIAN BLUE J



PLATINUM P



PURPLE K



RED L



YELLOW N