

intuit stack chair

model #: 00514

intuit (B shell) 14"h

DIMENSIONS + FREIGHT: *product is UPSable.

MODEL #	D"	W"	H"	F.C.	CUBE	WEIGHT
00514	17.6"	16.8"	14"	125	3.4	9 lbs.

OVERVIEW:

The Intuit is our most ergonomic option with unmatched comfort and style. The shell is contoured for comfort in the seat and the back. The first cooperative learning chair. It's shape was derived purely as an invitation to come, sit and learn. Meanwhile, it's ample dimensions make students of all sizes comfortable throughout the day. The Intuit chair is the latest expression of furniture that contributes to a healthy, effective learning environment.

MATERIALS:

The **SHELL** is 100% virgin polypropylene material with color throughout and a distinct texture to prevent slipping. The free flowing design of the Intuit comes from the innovative use of Gas Injection Technology. The integrated handle eases classroom positioning.

The **FRAME** is constructed from 16-gauge 1 1/8" diameter steel tube, protected by a durable powder coat finish and is MIG welded for maximum strength. The tubular frame supports the perimeter of the shell and incorporates a reinforcing crossbar for added strength. The shell is anchored securely to the frame through six 11-gauge die formed brackets, no rivets.

OPTIONS:

Nylon glide is standard.

Felt glide option : Add 'F' to follow Model No.

Steel glide option : Add 'S' to follow Model No.

(set of 4 installed - upcharge for felt or steel glide).

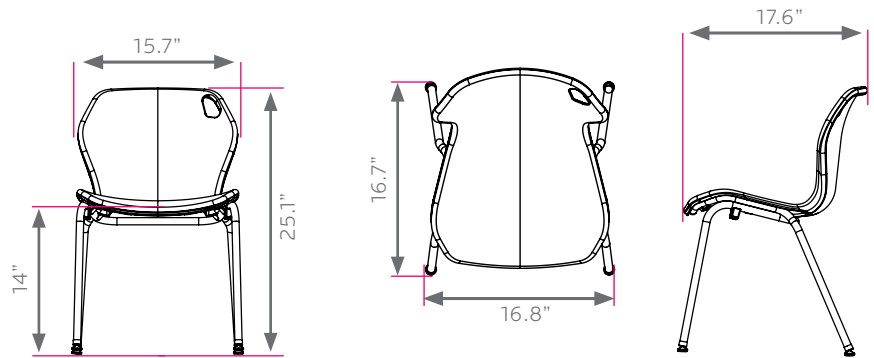

FRAME

- BLACK
- PLATINUM

SHELL

- APPLE
- BLACK
- BLUEBERRY
- BURGUNDY
- CERULEAN
- CHARCOAL
- CHOCOLATE
- CLEMENTINE
- FOREST GREEN
- FUCHSIA
- MINT
- MOCHA
- NAVY
- PERSIAN BLUE
- PURPLE
- RED
- WHITE
- YELLOW