



Model # Shown: EL48ES

OVERVIEW

Elemental tables have optional color casters and matching color leg sets. The unique color legs comes in three configurations; fixed height (EG), adjustable height (EA), fixed height for use with casters (EC), and low range adjustable height (EL).

MATERIALS

The 1 1/4" thick work surface consists of a 45 lb density particle board core with a 0.030" high pressure laminated surface and a 0.020" melamine backer sheet. The edge of the tabletop features your choice of a 3/8" bumper t-mold or 4mm t-mold, which is then fastened to the underside of the work surface every 6 to 8 inches to assure a long lasting fit. An 11 gauge steel stiffener is mounted under all table tops over 48" in width.

LEG STYLE 14 15

1. EG - Fixed-Height 30"
2. EC - Fixed-Height 27" (use w/ 3" casters = 30"H).
3. EA - Adjustable Height 19" - 33" (with glides)
4. EL - Low Range Adjustable Height 11" - 17" (with glides)

The Elemental leg sets are constructed of 14-gauge steel with a durable powdercoat paint finish in one of five colors. The legs are reinforced by a gusseted, 'spade' shaped, mounting plate. Each one of the 6 legs attach to the pre-drilled holes in the top with 10 #10 x 5/8" screws per leg. Legs come standard with a nylon base glide.

OPTIONAL CASTERS



Optional dual-wheel 3" casters available, ordered separately as their own line item. Engage Square Table uses 4-pack, model 17576 (for black) and 17577 (for color).

BUILD PART NUMBER

EL 4 2 E S | 7 8 9 | 10 | 11 12 13 | 14 15

Choose MODEL | Pick Laminate Color | Pick Edge Color | Pick Leg Color | Pick Leg Style

DIMENSIONS

Model	Description	Leg Type	D"	W"	H"	WT
EL42ES - EG	Engage Square Table	Fixed height w/glides	42	42	30	92
EL42ES - EC	Engage Square Table	Fixed height w/glides	42	42	27.5	96
EL42ES - EC*	Engage Square Table	Fixed height w/casters	42	42	30	96
EL42ES - EA	Engage Square Table	Adj. height w/glides	42	42	19-33	95
EL42ES - EL	Engage Square Table	Low range w/glides	42	42	11-17	

*Casters sold separately

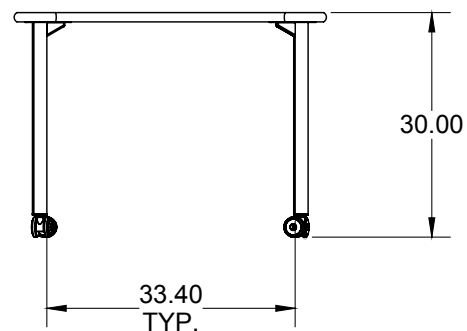
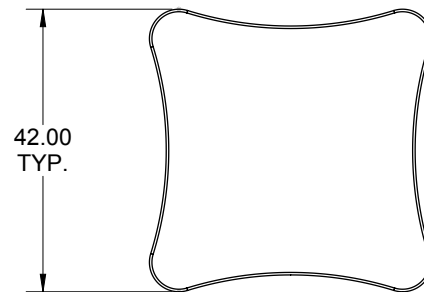

Drawings shown with 'EC' style legs, with optional 3" casters added.

STANDARD LAMINATE OPTIONS

Want to specify a different laminate?

No problem. If you have 20 or more tops of the same color -60 or -38 there is no upcharge. Have 20 or less? We can quote for you with the Wilsonart code and - finish style. We can specify other laminates - call to inquire and get a quote.

SUGGESTED SURFACE LAMINATE OPTIONS 7 8 9

						
ASIAN NIGHT 7949-60	BOARDWALK OAK 7983-60	BUKA BARK 7982-60	CLASSIC LINEN 4943-60	FLAX LINEN 4990-60	FRENCH PEAR 8220-60	FUSION MAPLE 7909-60
						
GREY NEBULA 4622-60	HIGH RISE 4996-60	MISSION MAPLE 7990-60	NEW AGE OAK 7938-60	NORTH SEA GRAY D90-60	PALISADES OAK 7987-60	PEWTER MESH 4878-60
	All 15 of the standard laminates are -60 finish, if you need to match a laminate from a previous year, please let us know on your order (example Pewter Mesh 4878-38, our standard is -60).					
WILD CHERRY 7054-60						

Top and Edge Options: 1 2

Standard (EL)
1 1/4" TOP W/ BUMPER T-MOLD
NO LETTER TO FOLLOW MODEL NO.

1 1/4" TOP W/ 3MM - 90° CORNERS
H

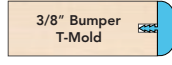
3/8" Bumper T-Mold 

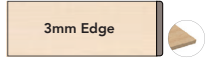
3mm Edge 

1 1/4" TOP W/ 4MM T-MOLD
D

1 1/4" TOP W/ 3MM - ROUND CORNERS
F

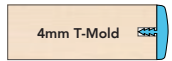
4mm T-Mold 

3mm Edge 

When the WilsonArt Laminate code includes a "Y", "K", "-12", "-78", "Aeon" etc, these are special laminates with an upcharge, even when it contains -38 or -60.







STANDARD EDGE COLOR OPTIONS 10

			
APPLE	BLACK	CERULEAN	CHARCOAL
			
MAPLE	NAVY	PERSIAN BLUE	PLATINUM

EDGE COLOR OPTIONS WITH ADDITIONAL LEAD TIME 10

			
BLUEBERRY	BURGUNDY	CHAMPAGNE	FOREST GREEN
			
ORANGE	PURPLE	RED	YELLOW

LEG COLOR OPTIONS **Additional Lead Time* 11 12 13

		
APPLE	CERULEAN	CHARCOAL
		
MAPLE ONLY AVAILABLE FOR (EL) LOW RANGE	PLATINUM	ORANGE*

ELEMENTAL LEG STYLE 14 15



3" Casters make table height 30."
Casters sold separately

LEG STYLE:

- EG - Fixed-Height 30"
- EC - Fixed-Height 27" (use w/ 3" casters = 30"H).
- EA - Adjustable Height (19" - 33" w/ glides) (21.5" - 35.5" w/ 3" casters)
- EL - Low Range Adjustable (11" - 17" w/ glides) (13.5" - 19.5" w/ 3" casters)