



**OVERVIEW**

Elemental tables have optional color casters and matching color leg sets. The unique color legs comes in three configurations; fixed height (EG), adjustable height (EA), fixed height for use with casters (EC), and low range adjustable height (EL).

**MATERIALS**

The 1 1/4" thick work surface consists of a 45 lb density particle board core with a 0.030" high pressure laminated surface and a 0.020" melamine backer sheet. The edge of the tabletop features your choice of a 3/8" bumper t-mold or 4mm t-mold, which is then fastened to the underside of the work surface every 6 to 8 inches to assure a long lasting fit. An 11 gauge steel stiffener is mounted under all table tops over 48" in width.

**LEG STYLE** 14 15

1. EG - Fixed-Height 30"
2. EC - Fixed-Height 27" (use w/ 3" casters = 30"H).
3. EA - Adjustable Height 19" - 33" (with glides)

The Elemental leg sets are constructed of 14-gauge steel with a durable powdercoat paint finish in one of five colors. The legs are reinforced by a gusseted, 'spade' shaped, mounting plate. Each one of the 6 legs attach to the pre-drilled holes in the top with 10 #10 x 5/8" screws per leg. Legs come standard with a nylon base glide.

**OPTIONAL CASTERS**



Optional dual-wheel 3" casters available, ordered separately as their own line item. Engage Square Table uses 4-pack, model 17576 (for black) and 17677 (for color).

**BUILD PART NUMBER**

EL 4 8 E S | 7 8 9 | 10 | 11 12 13 | 14 15

Choose MODEL | Pick Laminate Color | Pick Edge Color | Pick Leg Color | Pick Leg Style

**DIMENSIONS**

Model	Description	Leg Type	D"	W"	H"	WT
EL48ES - EG	Engage Square Table	Fixed height w/glides	48	48	30	102.5
EL48ES - EC	Engage Square Table	Fixed height w/glides	48	48	27.5	106.5
EL48ES - EC*	Engage Square Table	Fixed height w/casters	48	48	30	106.5
EL48ES - EA	Engage Square Table	Adj. height w/glides	48	48	19-33	105.5
EL48ES - EL	Engage Square Table	Low range w/glides	48	48	11-17	

\*Casters sold separately

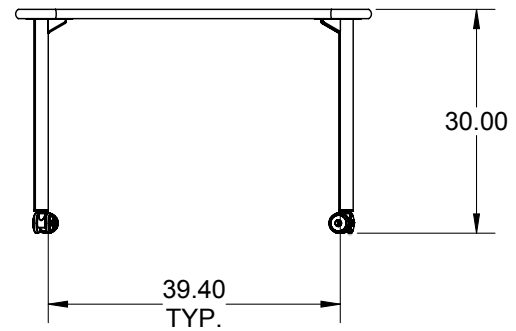

Drawings shown with 'EC' style legs, with optional 3" casters added.

## STANDARD LAMINATE OPTIONS

Want to specify a different laminate?

No problem. If you have 20 or more tops of the same color -60 or -38 there is no upcharge. Have 20 or less? We can quote for you with the Wilsonart code and - finish style. We can specify other laminates - call to inquire and get a quote.

## SUGGESTED SURFACE LAMINATE OPTIONS 7 8 9

						
ASIAN NIGHT 7949-60	BOARDWALK OAK 7983-60	BUKA BARK 7982-60	CLASSIC LINEN 4943-60	FLAX LINEN 4990-60	FRENCH PEAR 8220-60	FUSION MAPLE 7909-60
						
GREY NEBULA 4622-60	HIGH RISE 4996-60	MISSION MAPLE 7990-60	NEW AGE OAK 7938-60	NORTH SEA GRAY D90-60	PALISADES OAK 7987-60	PEWTER MESH 4878-60
	All 15 of the standard laminates are -60 finish, if you need to match a laminate from a previous year, please let us know on your order (example Pewter Mesh 4878-38, our standard is -60).					
WILD CHERRY 7054-60						

## Top and Edge Options: 1 2

**Standard (EL)**  
1 1/4" TOP W/ BUMPER T-MOLD  
NO LETTER TO FOLLOW MODEL NO.

1 1/4" TOP W/ 3MM - 90° CORNERS  
H

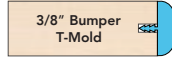
3/8" Bumper T-Mold 

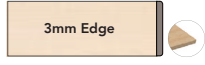
3mm Edge 

1 1/4" TOP W/ 4MM T-MOLD  
D

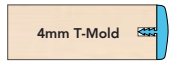

1 1/4" TOP W/ 3MM - ROUND CORNERS  
F

4mm T-Mold 

3mm Edge 

When the WilsonArt Laminate code includes a "Y", "K", "-12", "-78", "Aeon" etc, these are special laminates with an upcharge, even when it contains -38 or -60.







## STANDARD EDGE COLOR OPTIONS 10

			
APPLE	BLACK	CERULEAN	CHARCOAL
			
MAPLE	NAVY	PERSIAN BLUE	PLATINUM

## EDGE COLOR OPTIONS WITH ADDITIONAL LEAD TIME 10

			
BLUEBERRY	BURGUNDY	CHAMPAGNE	FOREST GREEN
			
ORANGE	PURPLE	RED	YELLOW

## LEG COLOR OPTIONS *\*Additional Lead Time* 11 12 13

		
APPLE	CERULEAN	CHARCOAL
		
MAPLE ONLY AVAILABLE FOR (EL) LOW RANGE	PLATINUM	ORANGE*

## ELEMENTAL LEG STYLE 14 15



3" Casters make table height 30."

Castors sold separately

### LEG STYLE:

- EG - Fixed-Height 30"
- EC - Fixed-Height 27" (use w/ 3" casters = 30"H).
- EA - Adjustable Height (19" - 33" w/ glides) (21.5" - 35.5" w/ 3" casters)
- EL - Low Range Adjustable (11" - 17" w/ glides) (13.5" - 19.5" w/ 3" casters)