



silhouette 18 x 24

29.5" fixed-height w/ glide

MODEL #: 01602

DIMENSIONS + FREIGHT

MODEL #	D"	W"	H"	F.C.	CUBE	WEIGHT
01602	18"	24"	29.5"	70	1.2	36 lbs.
carton	21"	28"	7"			

*for adjustable 19"-31"h leg see model #01600.

OVERVIEW

Shipped ready to assemble, these desks have a heavy-duty work surface that won't sag under heavy books or equipment. The Silhouette Desk is great for rows, pairs, or groupings for collaborative learning.

The WORK SURFACE consists of a 45 lb density particle board core with a .030" high pressure laminated surface and a .020" melamine backer sheet. The edge of the work surface features 3/8" bumper edge molding that is fastened every 6 to 8 inches to assure a long lasting fit. The frame is attached to the pre-drilled holes in the top with (6) #10 screws through a 1" x 1.75" 18-gauge steel channel. The mounting channel is welded to a 1" x 2" rectangular 16-gauge steel tube leg. The leg inserts are 1" x 1.75" 16-gauge steel tube and are fixed in height at 29.5".

The legs are tied together for added strength with a 1" x 2" 16-gauge steel tube stretcher bar and (4) bolts. Legs have 1" leveling glides. Book Box is optional (Model 17190), all welded 22-gauge steel construction that has a curled hem on the front opening. Book box comes in a BLACK powdercoat finish, or Platinum is special order only.

*Book box sold separately.

OPTIONAL ACCESSORIES

MODEL #		D"	W"	H"	F.C.	CUBE	WEIGHT
17190	steel bookbox	15"	20"	4"	70	3.0	8 lbs.
17200	wire book-basket	15"	18"	3.5"	70	3.0	5 lbs.
30925	SW tray w/ housing	16.8"	13.5"	3"	70	1.2	8 lbs.
30926	EW tray w/ housing	16.8"	19.6"	3"	70	1.2	10 lbs.
17576	3" casters, set of 4			3"	70	0.1	5 lbs.

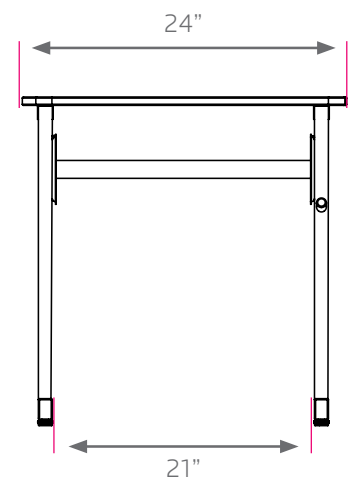
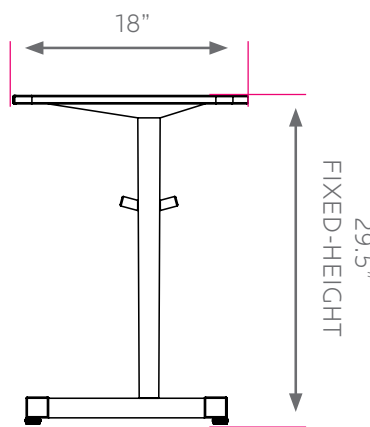
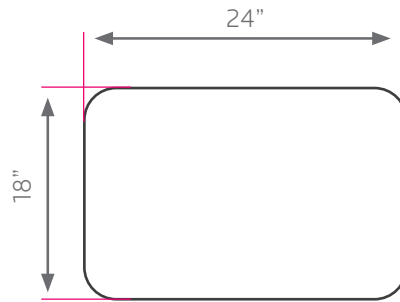

SILHOUETTE TOP & EDGE PROFILE

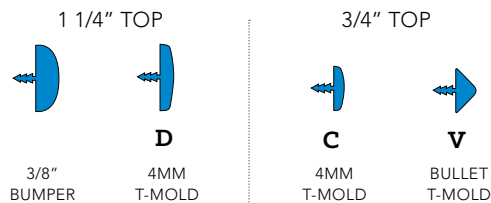

Silhouette Frame Color Options



BLACK
BLA



PLATINUM
PLT

Standard Laminate Options

Want to specify a different laminate?

No problem. If you have 20 or more tops of the same color -60 or -38 there is no upcharge. Have 20 or less? We can quote for you with the Wilsonart code and – finish style. We can specify other laminates – call to inquire and get a quote.



Suggested Standard Laminates:



ASIAN NIGHT
7949-60
ANG

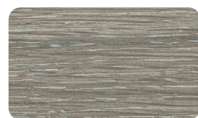

BOARDWALK OAK
7983-60
BWK

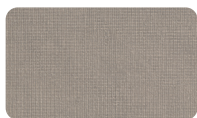

PEWTER MESH
4878-60
PEW



CLASSIC LINEN
4943-60
CLN



HIGH RISE
4996-60
HRE



BUKA BARK
7982-60
BBK



PALISADES OAK
7987-60
PSO



FLAX LINEN
4990-60
FLL



MISSION MAPLE
7990-60
MIM



NEW AGE OAK
7938-60
NEW

Classic Standard Laminates:

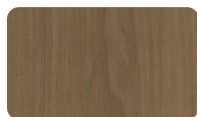

FRENCH PEAR
8220-60
FRP



WILD CHERRY
7054-60
CHE

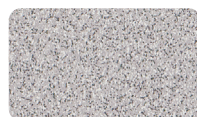

GREY NEBULA
4622-60
GNB



FUSION MAPLE
7909-60
MAP

All 14 of the standard laminates are -60 finish, if you need to match a laminate from a previous year, please let us know on your order (example Pewter Mesh 4878-38, our standard is -60).

When the WilsonArt Laminate code includes a "Y", "K", "-12" "-78", "Aeon" etc, these are special laminates with an upcharge, even when it contains -38 or -60.

Standard Edge Color Options



APPLE A



BLACK B



BLUEBERRY C



BURGUNDY D



CERULEAN S



CHAMPAGNE O



CHARCOAL R



CHOCOLATE Q



CLEMENTINE E



FOREST GREEN F



FUCHSIA G



MINT H



MOCHA T



NAVY I



ORANGE U



PERSIAN BLUE J



PLATINUM P



PURPLE K



RED L



YELLOW N

Smith System®

MODEL 01602 - NOVEMBER 2019