



silhouette 20 x 27

adjustable height w/ glide

MODEL #: 01650

DIMENSIONS + FREIGHT

| MODEL # | D" | W" | H" | F.C. | CUBE | WEIGHT |
|---------|-----|-----|-----------|------|------|---------|
| 01650 | 20" | 27" | 19" - 31" | 70 | 1.3 | 40 lbs. |
| carton | 21" | 28" | 7" | | | |

*for fixed-height 29.5" h leg set see model #: 01649. 01648.

OVERVIEW

Shipped ready to assemble, these desks have a heavy-duty work surface that won't sag under heavy books or equipment. The Silhouette Desk is great for rows, pairs, or groupings for collaborative learning.

The WORK SURFACE consists of a 45 lb density particle board core with a .030" high pressure laminated surface and a .020" melamine backer sheet. The edge of the work surface features 3/8" bumper edge molding that is fastened every 6 to 8 inches to assure a long lasting fit. The frame is attached to the pre-drilled holes in the top with (6) #10 screws through a 1" x 1.75" 18-gauge steel channel. The mounting channel is welded to a 1" x 2" rectangular 16-gauge steel tube leg. The leg inserts are 1" x 1.75" 16-gauge steel tube and adjust in height from 19" to 31" in 1" increments. The adjustment for each leg is secured with (2) allen screws.

The legs are tied together for added strength with a 1" x 2" 16-gauge steel tube stretcher bar and (4) bolts. Legs have 1" leveling glides. Book Box is optional (Model 17190), all welded 22-gauge steel construction that has a curled hem on the front opening. Book box comes in a BLACK powdercoat finish, or Platinum is special order only.
*Book box sold separately.

OPTIONAL ACCESSORIES

| MODEL # | | D" | W" | H" | F.C. | CUBE | WEIGHT |
|---------|----------------------|-------|-------|------|------|------|---------|
| 17190 | steel bookbox | 15" | 20" | 4" | 70 | 3.0 | 8 lbs. |
| 17200 | wire book-basket | 15" | 18" | 3.5" | 70 | 3.0 | 5 lbs. |
| 30925 | SW tray w/ housing | 16.8" | 13.5" | 3" | 70 | 1.2 | 8 lbs. |
| 30926 | EW tray w/ housing | 16.8" | 19.6" | 3" | 70 | 1.2 | 10 lbs. |
| 17576 | 3" casters, set of 4 | | | 3" | 70 | 0.1 | 5 lbs. |

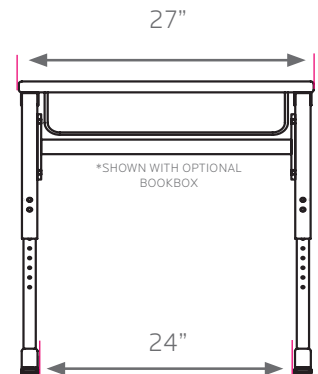
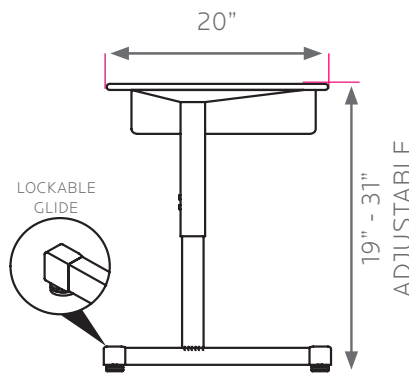
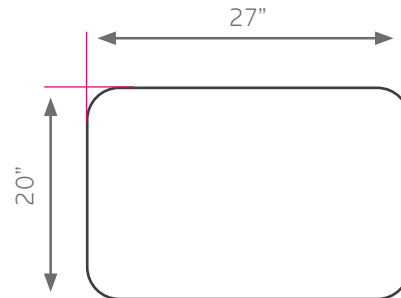

SILHOUETTE TOP & EDGE PROFILE

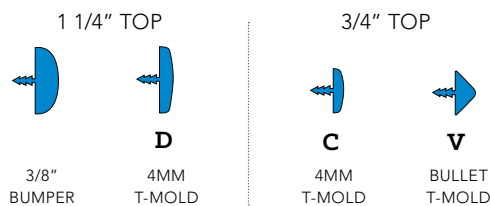

Silhouette Frame Color Options



BLACK
BLA



PLATINUM
PLT

Standard Laminate Options

Want to specify a different laminate?

No problem. If you have 20 or more tops of the same color -60 or -38 there is no upcharge. Have 20 or less? We can quote for you with the Wilsonart code and – finish style. We can specify other laminates – call to inquire and get a quote.



Suggested Standard Laminates:



ASIAN NIGHT
7949-60
ANG

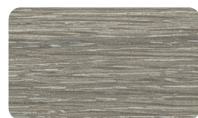

BOARDWALK OAK
7983-60
BWK

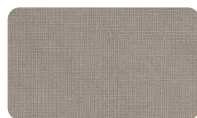

PEWTER MESH
4878-60
PEW



CLASSIC LINEN
4943-60
CLN



HIGH RISE
4996-60
HRE



BUKA BARK
7982-60
BBK



PALISADES OAK
7987-60
PSO



FLAX LINEN
4990-60
FLL



MISSION MAPLE
7990-60
MIM



NEW AGE OAK
7938-60
NEW

Classic Standard Laminates:

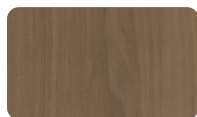

FRENCH PEAR
8220-60
FRP



WILD CHERRY
7054-60
CHE



GREY NEBULA
4622-60
GNB



FUSION MAPLE
7909-60
MAP

All 14 of the standard laminates are -60 finish, if you need to match a laminate from a previous year, please let us know on your order (example Pewter Mesh 4878-38, our standard is -60).

When the WilsonArt Laminate code includes a "Y", "K", "-12" "-78", "Aeon" etc, these are special laminates with an upcharge, even when it contains -38 or -60.

Standard Edge Color Options



APPLE A



BLACK B



BLUEBERRY C



BURGUNDY D



CERULEAN S



CHAMPAGNE O



CHARCOAL R



CHOCOLATE Q



CLEMENTINE E



FOREST GREEN F



FUCHSIA G



MINT H



MOCHA T



NAVY I



ORANGE U



PERSIAN BLUE J



PLATINUM P



PURPLE K



RED L



YELLOW N

Smith System®

MODEL 01650 - NOVEMBER 2019