



planner activity table

36" deep rectangles

MODEL #: 25550-25580

PLANNER ACTIVITY TABLES 36" DEEP
X 48", 60", 72" AND 90" LENGTH.

DIMENSIONS + FREIGHT

MODEL #	D"	W"	H"	F.C.	CUBE	WEIGHT
25550	36"	48"	24" - 34"	70	3.6	102 lbs.
25560	36"	60"	24" - 34"	70	4.5	118 lbs.
25570	36"	72"	24" - 34"	70	5.4	135 lbs.
25580	36"	90"	24" - 34"	70	6.8	158 lbs.

OVERVIEW

The Planner is ideal for all kinds of classroom activities. The heavy duty construction contributes to a sturdy work surface that can hold 400 pounds. The Planner Activity table is shipped ready to assemble.

The 1 1/4" or 3/4" thick WORK SURFACE consists of a 45 lb density particle board core with a .030" high pressure laminated surface and a .020" melamine backer sheet. The edge of the work surface features t-mold edge molding that is fastened every 6 to 8 inches to assure a long lasting fit.

The FRAME consists of two fully welded leg segments and a center support channel. The legs are attached to the pre-drilled holes in the top with (16) #10 x 5/8" wood screws through a 3 1/8" w x 18" L 12-gauge steel mounting plate. The mounting plate is welded to (2) 1 1/4" square 12-gauge steel tube legs which is welded to a 1" x 2" 14-gauge steel tube cross bar. The leg inserts are 1" square 14-gauge steel tube and adjust in height from 24" to 34" in 1" increments. Leveling glides are on each table leg allowing for stability on uneven floors. The adjustment for each leg is secured with (2) 3 3/4" -16 x .675" Allen screws. The center support channel is 2" x 3" 14-gauge steel, with 11-gauge steel end plates for maximum stability. The center support channel is connected to the legs by (4) connector bolts.

PLANNER TOP & EDGE PROFILE

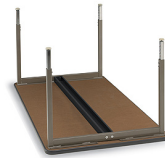
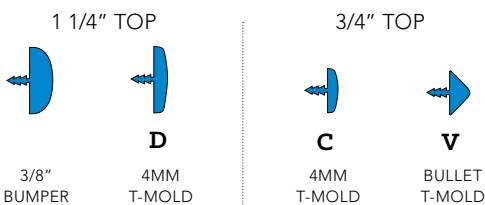

- Center support channel is 2" by 3" wide 14-gauge steel, with 11-gauge steel endplates for maximum stability.

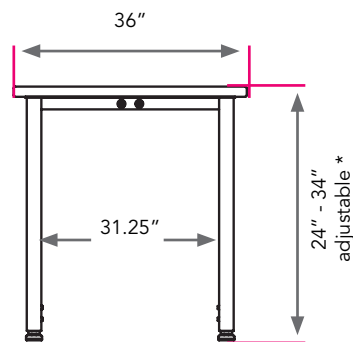
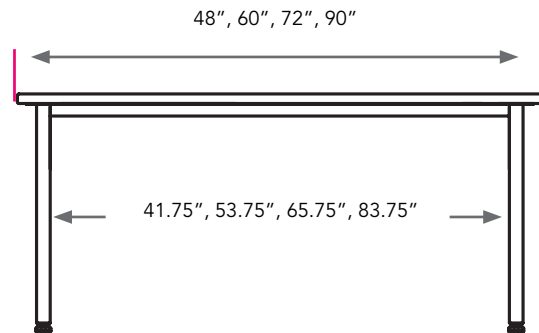

Frame Color Options



BLACK
BLA



PLATINUM
PLT

Alternate leg set heights:

- * Low range available in 15-24"h. Add **L** following model number.
- * Fixed-height leg available in 29.5"h. Add **X** following model number. Available in Black only.



Standard Laminate Options

Want to specify a different laminate?

No problem. If you have 20 or more tops of the same color -60 or -38 there is no upcharge. Have 20 or less? We can quote for you with the Wilsonart code and – finish style. We can specify other laminates – call to inquire and get a quote.



Suggested Standard Laminates:



ASIAN NIGHT
7949-60
ANG

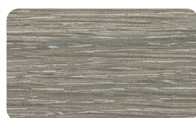

BOARDWALK OAK
7983-60
BWK



PEWTER MESH
4878-60
PEW



CLASSIC LINEN
4943-60
CLN



HIGH RISE
4996-60
HRE



BUKA BARK
7982-60
BBK



PALISADES OAK
7987-60
PSO



FLAX LINEN
4990-60
FLL



MISSION MAPLE
7990-60
MIM



NEW AGE OAK
7938-60
NEW

Classic Standard Laminates:

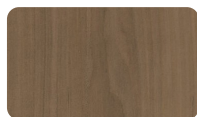

FRENCH PEAR
8220-60
FRP



WILD CHERRY
7054-60
CHE

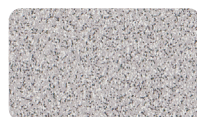

GREY NEBULA
4622-60
GNB



FUSION MAPLE
7909-60
MAP

All 14 of the standard laminates are -60 finish, if you need to match a laminate from a previous year, please let us know on your order (example Pewter Mesh 4878-38, our standard is -60).

When the WilsonArt Laminate code includes a "Y", "K", "-12" "-78", "Aeon" etc, these are special laminates with an upcharge, even when it contains -38 or -60.

Standard Edge Color Options



APPLE **A**



BLACK **B**



BLUEBERRY **C**



BURGUNDY **D**



CERULEAN **S**



CHAMPAGNE **O**



CHARCOAL **R**



CHOCOLATE **Q**



CLEMENTINE **E**



FOREST GREEN **F**



FUCHSIA **G**



MINT **H**



MOCHA **T**



NAVY **I**



ORANGE **U**



PERSIAN BLUE **J**



PLATINUM **P**



PURPLE **K**



RED **L**



YELLOW **N**

Smith System®