



planner studio tables

42" deep rectangles

MODEL #: 25218-25234

PLANNER STUDIO, 42" DEEP

DIMENSIONS + FREIGHT

Model	Description	D"	W"	H"	F.C.	WT
42" Deep Models (All tables come with casters only)						
25218f	42x48 Table	29" fixed-height	42	48	29	70 120
25220f	42x48 Table	36" fixed-height	42	48	36	70 123
25222f	42x48 Table	40" fixed-height	42	48	40	70 127
42" Deep Models (All tables come with casters only)						
25224f	42x60 Table	29" fixed-height	42	60	29	70 138
25226f	42x60 Table	36" fixed-height	42	60	36	70 141
25228f	42x60 Table	40" fixed-height	42	60	40	70 145
42" Deep Models (All tables come with casters only)						
25230f	42x72 Table	29" fixed-height	42	72	29	70 156
25232f	42x72 Table	36" fixed-height	42	72	36	70 159
25234f	42x72 Table	40" fixed-height	42	72	40	70 163



Shown at 29"H, 36"H and 40"H in Cerulean, Apple and Orange.

OVERVIEW

Planner Studio is ideal for all kinds of classroom activities. The heavy duty construction contributes to a sturdy work surface that can hold 400 pounds. The Planner Studio table is shipped ready to assemble.

The 1 1/4" thick WORK SURFACE consists of a 45 lb density particle board core with a .030" high pressure laminated surface and a .020" melamine backer sheet. The edge of the work surface features a 3mm flat self edge.

The FRAME consists of two fully welded leg segments and a center support channel. The legs are attached to the pre-drilled holes in the top with #10 x 5/8" wood screws through a 14-gauge steel mounting plate. The mounting plate is welded to (2) 60mm x 60mm 14-gauge steel square tube legs which are welded to a 1" x 2" 14-gauge steel tube cross bar. The center support channel is 2" x 3" 14-gauge steel, with 14-gauge steel end plates for maximum stability. The center support channel is connected to the legs by (4) connector bolts. 4" casters are standard.

PLANNER STUDIO EDGE PROFILE

F 3mm Edge 1 1/4" top with 3mm flat edge. F to follow Model No.

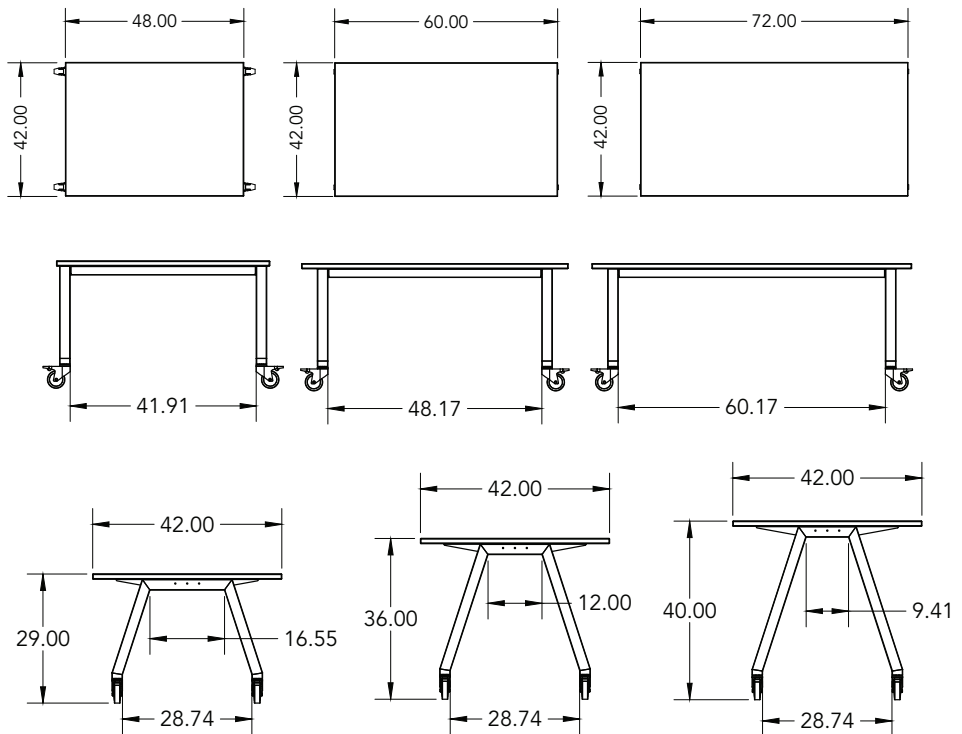

Laminates options: *(includes matching 3mm edge)*



PEWTER MESH
PEW



MISSION MAPLE
MIM



WHITEBOARD
WTB

- Whiteboard laminate, add \$125 to list price.
- 3mm edge finished in Grey [North Sea] on Whiteboard tops.
- Whiteboard laminate surface not warranted.



Frame Color Options



APPLE
AP



CERULEAN
CE



CHARCOAL
CG



ORANGE
OR



PLATINUM
PL

