



OVERVIEW

Elemental Student Desks come with a custom leg set that adjusts from 22.5" - 29.5" in 1" increments. Optional casters can be added - height maintains same adjustable range of 22.5" to 29.5".

MATERIALS

The 1 1/4" thick work surface consists of a 45 lb density particle board core with a 0.030" high pressure laminated surface and a 0.020" melamine backer sheet. The edge of the tabletop features your choice of a 3/8" bumper t-mold or 4mm t-mold, which is then fastened to the underside of the work surface every 6 to 8 inches to assure a long lasting fit.

Elemental Student Desk leg sets are constructed of 14-gauge steel with a durable powdercoat paint finish in one of five colors. The legs are reinforced by a gusseted, 'spade' shaped, mounting plate. Each one of the 4 legs attach to the pre-drilled holes in the top with 10 #10 x 5/8" screws per leg. Legs come standard with a nylon base glide. When adding the optional caster pack, the leg insert tube is removed and flipped, revealing the caster end of the leg. The adjustability remains the same at 22.5" to 29.5" with either caster or glide installed.

OPTIONAL CASTERS



Optional dual-wheel 3" casters available, ordered separately as their own line item.
Model 17576 (for black 4-pack).
Model 17577 (for color 4-pack).

BUILD PART NUMBER

EL **W I N G** **7 8 9 10** **11 12 13** **E S**

Choose MODEL Pick Laminate Color Pick Edge Color Pick Leg Color Pick Leg Style
(ES) 22.5" - 29.5" Adjustable Leg - Student Desks.

DIMENSIONS

Model	Description	D"	W"	H"	WT
ELWING	Elemental Wing Desk	23.5	41	22.5-29.5	42

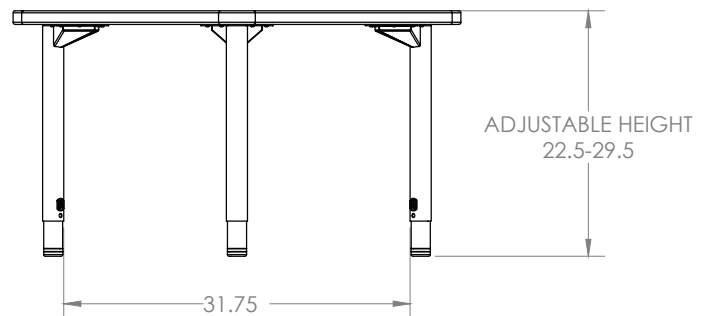
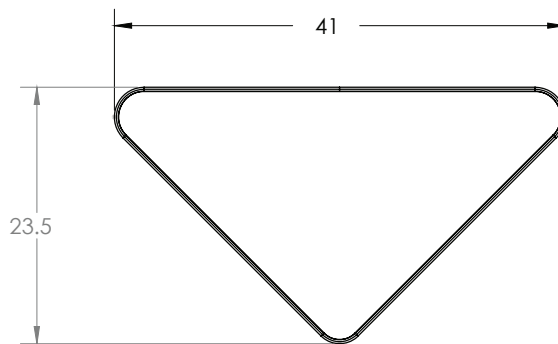

STANDARD LAMINATE OPTIONS

Want to specify a different laminate?

No problem. If you have 20 or more tops of the same color -60 or -38 there is no upcharge. Have 20 or less? We can quote for you with the Wilsonart code and - finish style. We can specify other laminates - call to inquire and get a quote.

SUGGESTED SURFACE LAMINATE OPTIONS 7 8 9

						
ASIAN NIGHT 7949-60	BOARDWALK OAK 7983-60	BUKA BARK 7982-60	CLASSIC LINEN 4943-60	FLAX LINEN 4990-60	FRENCH PEAR 8220-60	FUSION MAPLE 7909-60
						
GREY NEBULA 4622-60	HIGH RISE 4996-60	MISSION MAPLE 7990-60	NEW AGE OAK 7938-60	NORTH SEA GRAY D90-60	PALISADES OAK 7987-60	PEWTER MESH 4878-60
	All 15 of the standard laminates are -60 finish, if you need to match a laminate from a previous year, please let us know on your order (example Pewter Mesh 4878-38, our standard is -60).					
WILD CHERRY 7054-60						

Top and Edge Options: 1 2

Standard (EL)
1 1/4" TOP W/ BUMPER T-MOLD
NO LETTER TO FOLLOW MODEL NO.

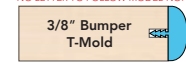
3/8" Bumper T-Mold 

3mm Edge 

1 1/4" TOP W/ 4MM T-MOLD
D

4mm T-Mold 





1 1/4" TOP W/ 3MM - 90° CORNERS
H

1 1/4" TOP W/ 3MM - ROUND CORNERS
F

3mm Edge 

When the WilsonArt Laminate code includes a "Y", "K", "-12", "-78", "Aeon" etc, these are special laminates with an upcharge, even when it contains -38 or -60.

STANDARD EDGE COLOR OPTIONS 10

			
APPLE	BLACK	CERULEAN	CHARCOAL
			
NAVY	PERSIAN BLUE	PLATINUM	

LEG COLOR OPTIONS 11 12 13

	
PLATINUM	CHARCOAL

EDGE COLOR OPTIONS WITH ADDITIONAL LEAD TIME 10

			
BLUEBERRY	BURGUNDY	CHAMPAGNE	FOREST GREEN
			
ORANGE	PURPLE	RED	YELLOW

ELEMENTAL LEG STYLE 14 15



LEG STYLE:
1. ES - Student Desk Leg Set,
22.5" - 29.5" Adjustability.