



OVERVIEW

Elemental tables have optional color casters and matching color leg sets. The unique color legs comes in three configurations; fixed height (EG), adjustable height (EA), fixed height for use with casters (EC), and low range adjustable height (EL).

MATERIALS

The 1 1/4" thick work surface consists of a 45 lb density particle board core with a 0.030" high pressure laminated surface and a 0.020" melamine backer sheet. The edge of the tabletop features your choice of a 3/8" bumper t-mold or 4mm t-mold, which is then fastened to the underside of the work surface every 6 to 8 inches to assure a long lasting fit. Mounted under the work surface is a 14 gauge steel 'X' shaped stiffener for reinforcement.

LEG STYLE 14 15

1. EG - Fixed-Height 30"
2. EC - Fixed-Height 27" (use w/ 3" casters = 30"H).
3. EA - Adjustable Height 19" - 33" (with glides)
4. EL - Low Range Adjustable Height 11" - 17" (with glides)

The Elemental leg sets are constructed of 14-gauge steel with a durable powdercoat paint finish in one of five colors. The legs are reinforced by a gusseted, 'spade' shaped, mounting plate. Each one of the 6 legs attach to the pre-drilled holes in the top with 10 #10 x 5/8" screws per leg. Legs come standard with a nylon base glide.

OPTIONAL CASTERS



Optional dual-wheel 3" casters available, ordered separately as their own line item. Squiggle Table uses 4-pack, model 17576 (for black) and 17677 (for color).

BUILD PART NUMBER

EL 7 2 S G | 7 8 9 | 10 | 11 12 13 | 14 15

Choose MODEL | Pick Laminate Color | Pick Edge Color | Pick Leg Color | Pick Leg Style

DIMENSIONS

| Model | Description | Leg Type | D" | W" | H" | WT |
|-------------|----------------|------------------------|----|----|-------|-----|
| EL72SG - EG | Squiggle Table | Fixed height w/glides | 41 | 72 | 30 | 104 |
| EL72SG - EC | Squiggle Table | Fixed height w/glides | 41 | 72 | 27.5 | 99 |
| EL72SG - EC | Squiggle Table | Fixed height w/casters | 41 | 72 | 30 | 99 |
| EL72SG - EA | Squiggle Table | Adj. height w/glides | 41 | 72 | 19-33 | 106 |
| EL72SG - EL | Squiggle Table | Low range w/glides | 41 | 72 | 11-17 | 105 |

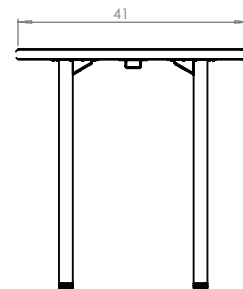
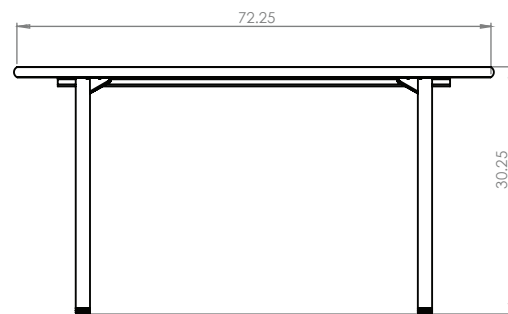
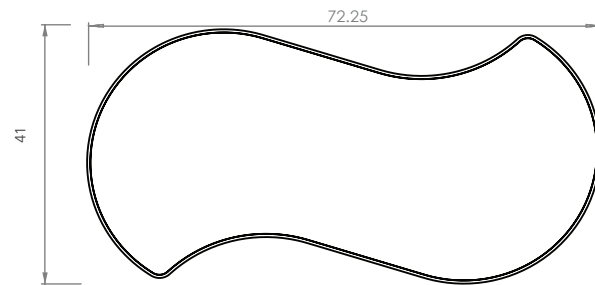

STANDARD LAMINATE OPTIONS

Want to specify a different laminate?

No problem. If you have 20 or more tops of the same color -60 or -38 there is no upcharge. Have 20 or less? We can quote for you with the Wilsonart code and - finish style. We can specify other laminates - call to inquire and get a quote.

SUGGESTED SURFACE LAMINATE OPTIONS 7 8 9

| | | | | | | |
|--|---|---|---|--|---|---|
|  |  |  |  |  |  |  |
| ASIAN NIGHT 7949-60 | BOARDWALK OAK 7983-60 | BUKA BARK 7982-60 | CLASSIC LINEN 4943-60 | FLAX LINEN 4990-60 | FRENCH PEAR 8220-60 | FUSION MAPLE 7909-60 |
|  |  |  |  |  |  |  |
| GREY NEBULA 4622-60 | HIGH RISE 4996-60 | MISSION MAPLE 7990-60 | NEW AGE OAK 7938-60 | NORTH SEA GRAY D90-60 | PALISADES OAK 7987-60 | PEWTER MESH 4878-60 |
|  | All 15 of the standard laminates are -60 finish, if you need to match a laminate from a previous year, please let us know on your order (example Pewter Mesh 4878-38, our standard is -60). | | | | | |
| WILD CHERRY 7054-60 | | | | | | |

Top and Edge Options: 1 2

Standard (EL)
1 1/4" TOP W/ BUMPER T-MOLD
NO LETTER TO FOLLOW MODEL NO.

1 1/4" TOP W/ 3MM - 90° CORNERS
H

3/8" Bumper T-Mold

3mm Edge

1 1/4" TOP W/ 4MM T-MOLD
D

1 1/4" TOP W/ 3MM - ROUND CORNERS
F

4mm T-Mold

3mm Edge

When the WilsonArt Laminate code includes a "Y", "K", "-12", "-78", "Aeon" etc, these are special laminates with an upcharge, even when it contains -38 or -60.







STANDARD EDGE COLOR OPTIONS 10

| | | | |
|--|---|---|---|
|  |  |  |  |
| APPLE | BLACK | CERULEAN | CHARCOAL |
|  |  |  |  |
| MAPLE | NAVY | PERSIAN BLUE | PLATINUM |

EDGE COLOR OPTIONS WITH ADDITIONAL LEAD TIME 10

| | | | |
|--|---|---|---|
|  |  |  |  |
| BLUEBERRY | BURGUNDY | CHAMPAGNE | FOREST GREEN |
|  |  |  |  |
| ORANGE | PURPLE | RED | YELLOW |

LEG COLOR OPTIONS **Additional Lead Time* 11 12 13

| | | |
|--|---|---|
|  |  |  |
| APPLE | CERULEAN | CHARCOAL |
|  |  |  |
| MAPLE ONLY AVAILABLE FOR (EL) LOW RANGE | PLATINUM | ORANGE* |

ELEMENTAL LEG STYLE 14 15



3" Casters make table height 30."

Castors sold separately

LEG STYLE:

- EG - Fixed-Height 30"
- EC - Fixed-Height 27" (use w/ 3" casters = 30"H).
- EA - Adjustable Height (19" - 33" w/ glides) (21.5" - 35.5" w/ 3" casters)
- EL - Low Range Adjustable (11" - 17" w/ glides) (13.5" - 19.5" w/ 3" casters)