



OVERVIEW

Numbers desk is a winning answer for creating inspirational classrooms around the world. The desk delivers impressive benefits that add up for students and schools - great value and quality in a compact, sleek design that appeals to all ages. This desk answers the need for value-driven, high-quality classroom solutions with international design appeal. The product specifications is designed to comply with BIFMA, EN, & GB standards for durability, performance and sizing. Together, the chair + desk suite equals a smart solution for students, teachers and facility personnel.

MATERIALS

The leg sets are made of 14 gauge steel circular stems and inserts. Larger tube 28.6mm x 14ga. steel and smaller tube 22mm x 14ga. steel. Standard inserts range from 24.5 to 30 inches; low-range inserts are 19 to 24.5 inches (Low range inserts sold separately). In addition, the inner leg tube can flip 180 degrees between glides or casters (sold separately), which allows for wheelbarrowing without affecting desk height.

The leg consists of one fully welded segment. Legs have a full, even and long lasting powdercoat finish. To conserve space, the desks have a compact design. Their leg form, coupled with backpack hooks (with felt) on all four legs, allow easy slide-on stacking, three or four desks at a time.

The work surface is made of 1 1/4" thick, high density particle board core, with HP laminate top surface. Tops are pre-drilled for leg set attachment and ease of installation.

NUMBERS DESK TOP & EDGE PROFILE

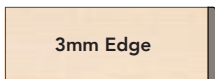

1 1/4" top w/ 3mm

DIMENSIONS

Model	Description	D"	W"	H"	WT
02132	Numbers Petal Desk	29.5	33.5	24.5-30	39
02135	Numbers Petal Desk - Left	29.5	33.5	24.5-30	39

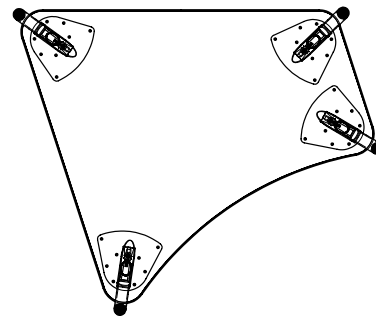
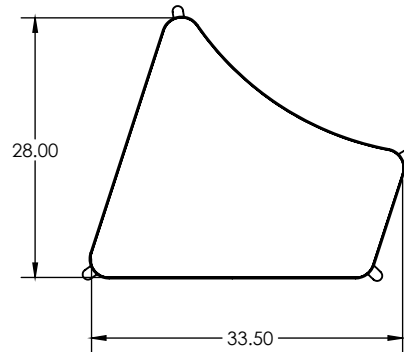

2" Caster w/lock

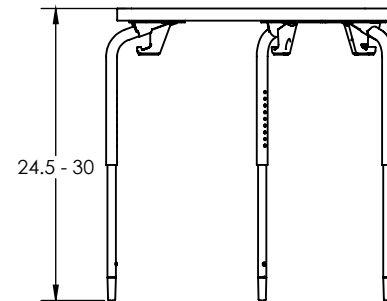

Model: 60168BLA (4 pack)
2" Caster w/lock

STANDARD LAMINATE OPTIONS

Want to specify a different laminate?

No problem. If you have 20 or more tops of the same color -60 or -38 there is no upcharge. Have 20 or less? We can quote for you with the Wilsonart code and - finish style. We can specify other laminates - call to inquire and get a quote.

SUGGESTED LAMINATE OPTIONS



ASIAN NIGHT
7949-60



BOARDWALK OAK
7983-60



BUKA BARK
7982-60

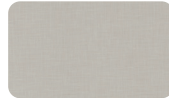

CLASSIC LINEN
4943-60

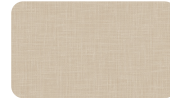

FLAX LINEN
4990-60

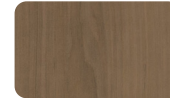

FRENCH PEAR
8220-60



FUSION MAPLE
7909-60



GREY NEBULA
4622-60



HIGH RISE
4996-60



MISSION MAPLE
7990-60



NEW AGE OAK
7938-60



NORTH SEA GRAY
D90-60



PALISADES OAK
7987-60

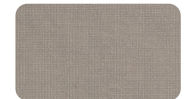

PEWTER MESH
4878-60



WILD CHERRY
7054-60

All 15 of the standard laminates are -60 finish, if you need to match a laminate from a previous year, please let us know on your order (example Pewter Mesh 4878-38, our standard is -60).

When the WilsonArt Laminate code includes a "Y", "K", "-12" "-78", "Aeon" etc, these are special laminates with an upcharge, even when it contains -38 or -60.

STANDARD EDGE COLOR OPTIONS



APPLE



BLACK



CERULEAN



CHARCOAL



NAVY



PERSIAN BLUE



PLATINUM

LEG COLOR OPTION



PLATINUM

EDGE COLOR OPTIONS WITH ADDITIONAL LEAD TIME



BLUEBERRY



BURGUNDY



CHAMPAGNE



FOREST GREEN



ORANGE



PURPLE



RED



YELLOW